

# TECHNICAL REVIEW

Danish Primary Laboratory of Acoustics  
Microphone Reciprocity Calibration  
Calculation Program for Reciprocity  
Calibration



NO. 1 1998

Brüel & Kjær 

# Technical Review

No. 1 – 1998

# Contents

Danish Primary Laboratory of Acoustics (DPLA) as Part of the National Metrology Organisation .....	1
<i>Kim Carneiro</i>	
Pressure Reciprocity Calibration – Instrumentation, Results and Uncertainty .....	5
<i>Erling Frederiksen and Jørgen I.Christensen</i>	
MP.EXE, a Calculation Program for Pressure Reciprocity Calibration of Microphones .....	27
<i>Knud Rasmussen</i>	

Copyright © 1998, Brüel & Kjær Sound & Vibration Measurement A/S  
All rights reserved. No part of this publication may be reproduced or distributed in any form, or  
by any means, without prior written permission of the publishers. For details, contact:  
Brüel & Kjær Sound & Vibration Measurement A/S, DK-2850 Nærum, Denmark.

Editor: Harry K. Zaveri  
Layout: Helle Smidt

Photographer: Peder Dalmo  
Printed by SLM Grafisk



# Previously issued numbers of Brüel & Kjær Technical Review

- 1–1997 A New Design Principle for Triaxial Piezoelectric Accelerometers  
A Simple QC Test for Knock Sensors  
Torsional Operational Deflection Shapes (TODS) Measurements
- 2–1996 Non-stationary Signal Analysis using Wavelet Transform, Short-time  
Fourier Transform and Wigner-Ville Distribution
- 1–1996 Calibration Uncertainties & Distortion of Microphones.  
Wide Band Intensity Probe. Accelerometer Mounted Resonance Test
- 2–1995 Order Tracking Analysis
- 1–1995 Use of Spatial Transformation of Sound Fields (STSF) Techniques in the  
Automotive Industry
- 2–1994 The use of Impulse Response Function for Modal Parameter Estimation  
Complex Modulus and Damping Measurements using Resonant and  
Non-resonant Methods (Damping Part II)
- 1–1994 Digital Filter Techniques vs. FFT Techniques for Damping  
Measurements (Damping Part I)
- 2–1990 Optical Filters and their Use with the Type 1302 & Type 1306  
Photoacoustic Gas Monitors
- 1–1990 The Brüel & Kjær Photoacoustic Transducer System and its Physical  
Properties
- 2–1989 STSF — Practical Instrumentation and Application  
Digital Filter Analysis: Real-time and Non Real-time Performance
- 1–1989 STSF — A Unique Technique for Scan Based Near-Field Acoustic  
Holography Without Restrictions on Coherence
- 2–1988 Quantifying Draught Risk
- 1–1988 Using Experimental Modal Analysis to Simulate Structural Dynamic  
Modifications  
Use of Operational Deflection Shapes for Noise Control of Discrete  
Tones
- 4–1987 Windows to FFT Analysis (Part II)  
Acoustic Calibrator for Intensity Measurement Systems
- 3–1987 Windows to FFT Analysis (Part I)
- 2–1987 Recent Developments in Accelerometer Design  
Trends in Accelerometer Calibration
- 1–1987 Vibration Monitoring of Machines
- 4–1986 Field Measurements of Sound Insulation with a Battery-Operated  
Intensity Analyzer  
Pressure Microphones for Intensity Measurements with Significantly  
Improved Phase Properties  
Measurement of Acoustical Distance between Intensity Probe  
Microphones

*(Continued on cover page 3)*

# Previously issued numbers of Brüel & Kjær Technical Review

*(Continued from cover page 2)*

- Wind and Turbulence Noise of Turbulence Screen, Nose Cone and Sound Intensity Probe with Wind Screen
- 3–1986 A Method of Determining the Modal Frequencies of Structures with Coupled Modes  
Improvement to Monoreference Modal Data by Adding an Oblique Degree of Freedom for the Reference
- 2–1986 Quality in Spectral Match of Photometric Transducers  
Guide to Lighting of Urban Areas
- 1–1986 Environmental Noise Measurements
- 4–1985 Validity of Intensity Measurements in Partially Diffuse Sound Field  
Influence of Tripods and Microphone Clips on the Frequency Response of Microphones
- 3–1985 The Modulation Transfer Function in Room Acoustics  
RASTI: A Tool for Evaluating Auditoria
- 2–1985 Heat Stress  
A New Thermal Anemometer Probe for Indoor Air Velocity Measurements
- 1–1985 Local Thermal Discomfort
- 4–1984 Methods for the Calculation of Contrast  
Proper Use of Weighting Functions for Impact Testing  
Computer Data Acquisition from Brüel & Kjær Digital Frequency Analyzers 2131/2134 Using their Memory as a Buffer

## Special technical literature

Brüel & Kjær publishes a variety of technical literature which can be obtained from your local Brüel & Kjær representative.

The following literature is presently available:

- Acoustic Noise Measurements (English), 5th. Edition
- Noise Control (English, French)
- Frequency Analysis (English), 3rd. Edition
- Catalogues (several languages)
- Product Data Sheets (English, German, French, Russian)

Furthermore, back copies of the Technical Review can be supplied as shown in the list above. Older issues may be obtained provided they are still in stock.

# Danish Primary Laboratory of Acoustics (DPLA) as Part of the National Metrology Organisation

*Kim Carneiro\**

When the Danish Government, in 1989, nominated the Danish Primary Laboratory of Acoustics (DPLA), it was probably the first time that an instrument manufacturer (Brüel & Kjær) became involved in the maintenance of national measurement standards. Even if this action is uncommon, it was part of a deliberate strategy for building a viable Danish metrology organisation; and after several years of operation it is fair to conclude that it has worked out very well. The present article describes some of the thoughts that went behind it and some of the factors that have contributed to its success.

In the early 1980's Denmark found itself without a national metrology institute that could meet the present and foreseen needs of Danish industry. A national accreditation scheme was in place, but measurement traceability was not taken care of in a way that foreign trading partners would accept as adequate for an industrial country. A parliamentary commission was charged with a report and as a result it was decided to establish the *Danish Institute of Fundamental Metrology (DFM)* as well as a decentralised organisation of competent primary and national reference laboratories. DPLA was the first primary laboratory to be nominated outside DFM.

The reason for this decision was the same as the reason that had led to the establishment of the accreditation service some ten years earlier. As a small country (5 million inhabitants) with an industry consisting of mainly small enterprises with a widespread need in measurements and testing, it was realised that the state budget could not sustain a metrology infrastructure that would satisfy even a significant fraction of the needs. On the other hand something had to be done to change the reputation of Danish metrology from being mediocre to good. It was therefore decided to privatise and liberalise measurement and testing through accreditation and to establish a decentralised metrology organisation which, apart from DFM, was built on expertise available at institutions or companies outside the traditional metrology circles. Brüel & Kjær was immediately recognised as a candidate for a national laboratory for acoustics and vibrations.

In accordance with overall plans for development of metrology in Denmark, DPLA maintains standards for airborne acoustics and vibrations in Denmark.

---

\* Director of Danish Institute of Fundamental Metrology (DFM) Byg. 307; Anker Engelunds vej 1; 2800 Lyngby

Being a joint operation between the Technical University of Denmark and Brüel & Kjær, DPLA combines academic science with the manufacture of precision instruments; although an unorthodox establishment it has been able to perform as a respected national laboratory, with the following tasks:

- 1) Participation in international comparisons. DPLA compares its primary standards on a regular basis with NIST, it has taken part in EUROMET comparisons and is being proposed as a pilot laboratory for EAL-comparisons.
- 2) Dissemination of traceable measurements within Denmark. DPLA offers accredited calibration with traceability to its primary standards.
- 3) Participation in international metrology collaboration. DPLA is represented in a number of standardisation committees and DPLA has been a valued partner, when other countries were looking for help to establish metrology facilities to meet their needs.
- 4) Teaching. The unique mix of expertise in DPLA has made it possible to teach at all levels in metrology, from the highest academic level to down to earth industrial level.

Of course, entrusting a commercial enterprise with the maintenance of national measurement standards, cannot be granted without conditions, if the national credibility is to be accepted by the foreign trading partners with very different policies for the deployment of measurement standards. Therefore very stringent principles are applied before a Danish primary laboratory is nominated by the National Agency for Trade and Industry. These are:

- a) International evaluation. Before nomination, candidates are evaluated by an international team, ensuring the adequate competence with respect to all functions as a national laboratory. Particular attention is given to whether the applicant possesses *primary* standards in which case it is nominated primary laboratory. Otherwise, if the candidate is traceable to a foreign laboratory, the nomination is for *national reference laboratory*.
- b) Dissemination of accredited calibration. The calibration of the national laboratory must be performed under a DANAK accreditation. This ensures the quality of the traceability to the national standards, be primary or secondary; and it also ensures the impartiality of the laboratory as manifested in clause 4 of EN 45001.

The nomination of DPLA was a landmark in Danish metrology, since it was the first nomination involving a private production industry. It has later been followed by several other examples, so that the Danish organisation of metrology laboratories presently consist of 9 participants. They represent Universities, state-operated laboratories, independent research organisations. They are assembled in DANIAmet and closely supervised by the National Agency.



## Nomination as Primary Laboratory for Acoustical Measurements in Gases and for Accelerometry



The Danish Agency for Development of Trade and Industry hereby announces that it has entered into contract with

DANISH PRIMARY LABORATORY  
OF ACOUSTICS,  
BRÜEL AND KJÆR A/S  
Skodsborgvej 307  
DK-2850 Nærum  
Denmark

concerning the establishment and maintenance of a  
Primary Laboratory for Acoustical Measurements  
in Gases and Solids and for Accelerometry

The contract has been entered on the basis of paragraph 10, part 1, cf. paragraph 16, part 4 of the Ministry of Industry consolidated act No. 84, dated February 22, 1993.

Danish Primary Laboratory of Acoustics, which is operated by an independent department of Brüel and Kjær A/S in cooperation with the Acoustic Laboratory of the Technical University of Denmark, is under an obligation to establish and to continuously maintain and develop calibration facilities and methods following international recommendations, so that sound and vibration transducers can be calibrated at the highest international level.

The full contract is given in code 1987-725/000-48.

Copenhagen, April 23, 1995

MOGENS KRINGS

General-Director, M.Sc.  
Danish Agency for Development of Trade and Industry  
Ministry of Business and Industry

Laboratorium: **Brüel & Kjær Sound & Vibration A/S**  
**Dansk Primær Laboratorium for Akustik**  
Skodsborgvej 307  
2850 Nærum

Akkreditering til: **Kalibrering inden for lyd- og vibrationsområdet**  
Registreringsnummer: **277**  
Gyldig til: **2001 11 30**  
Prøvningsområde:

**Kalibrering af:**

- Mikrofoner.
- Vibrationstransducere.

**Kalibrering udføres i henhold til specifikation af måle-  
område og målevæne godkendt af Dansk Akkreditering.**

Akkrediteringen er meddelt i medfør af §5 i Erhvervsfremme Styrelsens bekendtgørelse nr. 258 af 11. april 1994 om akkreditering af laboratorier til teknisk prøvning mv., EN 45001 er en integreret del af ovennævnte bekendtgørelse.

Laboratoriet er undergivet de til enhver tid fastsatte forskrifter angående dets virksomhed som akkrediteret laboratorium samt de for denne akkreditering særligt fastsatte vilkår, som er meddelt laboratoriet særskilt.

Dato: **1997 08 25**

Dansk Akkreditering  
DANAK



**Mette Holst / Niels Rudolph Hartmann**

# Pressure Reciprocity Calibration – Instrumentation, Results and Uncertainty

Erling Frederiksen and Jørgen I. Christensen.

## Abstract

This article is written in connection with the release of a new automated Microphone Reciprocity Calibration System for national and other high level calibration laboratories. The accuracy of practically all acoustic measurements is based on pressure reciprocity calibrations. The principle of this primary calibration method is briefly described together with a more detailed description of the past and present reciprocity measurement instruments and systems which have been produced by Brüel & Kjær for more than 40 years. To cover the need for calibrations within the company, Brüel & Kjær has not only produced such instruments but has also for about 30 years operated its own primary calibration laboratory and used the instruments for periodic calibrations. The article describes calibration comparisons and spread of results obtained during this time. It also describes the calculated uncertainty valid for customer calibrations performed since 1991 when Brüel & Kjær's primary laboratory got status of a technically independent department and was nominated by the government as the Danish Primary Laboratory of Acoustics.

## Résumé

Cet article accompagne la présentation d'un nouveau Système automatisé d'Étalonnage de microphones par réciprocité destiné aux centres d'étalonnage primaires à l'échelon national. La précision de la plupart des mesures acoustiques est basée sur un étalonnage primaire par réciprocité en pression. Le principe de cette procédure y est décrit brièvement. Cette description s'accompagne d'une rétrospective plus détaillée de l'instrumentation et des systèmes Brüel & Kjær consacrés aux mesures par réciprocité depuis plus de quarante ans. Pour couvrir les besoins internes à l'entreprise, la société Brüel & Kjær gère également depuis trois décennies son propre laboratoire d'étalonnage pri-

maire et utilise sa propre instrumentation pour des étalonnages périodiques. Les comparaisons entre procédures et les divergences entre les résultats obtenus au cours de cette période sont également traitées.

Y est traitée enfin l'incertitude calculée valide pour les services d'étalonnage client proposés depuis 1991, année où le laboratoire primaire de Brüel & Kjær a acquis le statut de centre indépendant sur le plan technique et a été désigné Laboratoire Danois d'Acoustique Primaire, (DPLA), par le gouvernement danois.

## Zusammenfassung

Dieser Artikel entstand in Verbindung mit der Freigabe eines neuen automatisierten Reziprozitäts-Mikrofonkalibriersystem für nationale und andere hochrangige Kalibrierlaboratorien. Die Genauigkeit praktisch aller akustischer Messungen beruht auf Druckkalibrierungen nach der Reziprozitätsmethode. Das Prinzip dieser Primärkalibriermethode wird kurz beschrieben, während frühere und heutige Reziprozitäts-Meßgeräte und -systeme, die Brüel & Kjær seit mehr als 40 Jahren produziert, ausführlicher behandelt werden. Um den firmeninternen Kalibrierbedarf zu decken, stellt Brüel & Kjær solche Geräte nicht nur her, sondern betreibt auch seit ca. 30 Jahren ein eigenes Primärkalibrierlaboratorium und setzt die Geräte zur regelmäßigen Kalibrierung ein. Der Artikel beschreibt Kalibriervergleiche und Ergebnisstreuung in Laufe der Zeit. Er erläutert auch die berechnete Unsicherheit für Kundenkalibrierungen, die seit 1991 ausgeführt werden. Damals erhielt Brüel & Kjær's Primärlaboratorium den Status einer technisch unabhängigen Abteilung und wurde von der Regierung zum dänischen Primärlaboratorium für Akustik ernannt.

## Introduction

The sensitivity of a measurement microphone is most commonly determined by comparison with that of another microphone, a Reference Standard Microphone. The two microphones are exposed to the same sound field, either simultaneously or successively, while their output voltages are measured and compared. Such simple comparison calibrations are widely used.

However, the Reference Standard Microphone (see Fig. 1) has to be calibrated in a different way. Today, Reciprocity Calibration is the method generally used for this purpose. With reciprocity calibration no reference is made to



*Fig. 1. The Brüel & Kjær Laboratory Standard Microphones Type 4160 (23.77 mm diameter – named one inch) and Type 4180 (half inch diameter) are the Reference Standard Microphones which are most commonly used by national and other well established calibration laboratories. The microphones meet the requirements valid for types LS2p and LS1p of the international standard IEC 61094-1*

any acoustic quantity like microphone sensitivity (V/Pa) nor sound pressure (Pa) but only to fundamental electrical, mechanical and physical parameters like DC voltage, frequency, length, air density, temperature, static pressure etc. Such a method of calibration is called an absolute or primary calibration method while comparison calibration is a secondary method.

Primary calibration methods are used by relatively few laboratories, such as National Calibration Laboratories and few large automotive, space or governmental organizations which work at a high technological level. Secondary methods are used by several laboratories for calibration and verification of commonly used measurement microphones.

Like other measurement probes and transducers the microphone due to its presence disturbs the field and therefore influences the quantity to be measured, the sound pressure. This influence depends partly on the microphone itself and partly on the type of sound field. Thus microphones have different sensitivities for the three principal types of field, i.e. pressure-field, free-field and diffuse-field.

In principle, the three different types of sensitivity may be found by performing pressure-field, free-field and diffuse-field reciprocity calibrations. However, diffuse-field reciprocity calibration especially is associated with serious technical problems and is therefore not used in practice. Free-field reciprocity cali-

bration is technically less complicated and works well, especially at higher frequencies, but it is quite costly to perform. It requires an anechoic room and great care needs to be taken to avoid noise and cross-talk problems.

Pressure-field reciprocity calibration is in practice the most easy and less costly method. By proper instrumentation a high accuracy and repeatability may be reached and a wide frequency range may be covered with this method.

The pressure reciprocity calibration leads to the pressure sensitivity only. However, for a specific type of microphone the free-field and diffuse-field sensitivities differ from the pressure-field sensitivity only by essentially fixed frequency dependent constants. Therefore, if these constants are known, free-field and diffuse-field sensitivities may be obtained by correcting measured pressure sensitivities.

Today, pressure calibrations are performed by several laboratories in the world while only few laboratories are able to make free-field calibrations. Some leading acoustic calibration laboratories have published corrections which make it possible to determine free-field and diffuse-field sensitivities from measured pressure sensitivities. This has contributed towards making the pressure reciprocity calibration the most widely used method for primary microphone calibration.

## Pressure Reciprocity Calibration Principle

Reciprocity calibration can be made with reciprocal transducers only. The condenser microphone which can work in two different modes, either as a receiver or a transmitter of sound is a reciprocal transducer. It emits sound if current is fed through its electrical terminals.

More specifically for a microphone to be reciprocal it must behave like a passive, linear two-port network with a ratio of response to excitation which is the same for the two operation modes. For a condenser microphone this means that the ratio of output voltage to acoustic volume velocity (receiver operation) must be equal to the ratio of pressure on diaphragm to electrical input current (transmitter operation). The conditions are to be valid with unloaded electrical terminals and with blocked diaphragm respectively.

The reciprocity theorem is not only valid for the condenser microphone itself but also for the combined electrical, mechanical and acoustical network which is made up of a transmitter and a receiver microphone coupled to each other via an acoustic impedance. This makes reciprocity calibration possible. During pressure reciprocity calibration the microphones are coupled together by the air (gas) enclosed in a cavity. One microphone operates as transmitter and

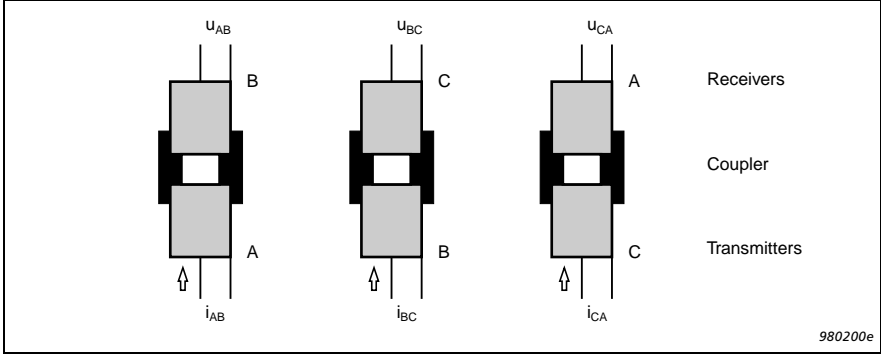

Fig. 2. Principle of Pressure Reciprocity Calibration. The 3 microphones (A, B and C) are coupled 2 at a time together by the air (or gas) enclosed in a cavity while the three ratios of output voltage and input current are measured. Each ratio equals the Electrical Transfer Impedance valid for the respective pair of microphones

emits sound into the cavity which is detected by the receiver microphone. The dimensions of the cavity and the acoustic impedance of the microphones must be known while the properties (pressure, temperature and composition) of the gas (air) in the coupler must be controlled or monitored in connection with the measurement. These parameters are used for the succeeding calculations of Acoustic Transfer Impedance and microphone sensitivity.

Three microphones (A, B and C) are used, see Fig. 2. They are pair-wise (AB, BC and CA) coupled together. For each pair the receiver output voltage and the transmitter input current are measured and their ratio which is called the Electrical Transfer Impedance is calculated. After having determined the electrical impedance and calculated the acoustic transfer impedance for each microphone combination, the sensitivities of all the three microphones may be calculated by solving the equations below.

$$M_{p,A} \times M_{p,B} = \frac{Z_{e,AB}}{Z_{a,AB}}; \quad M_{p,B} \times M_{p,C} = \frac{Z_{e,BC}}{Z_{a,BC}}; \quad M_{p,C} \times M_{p,A} = \frac{Z_{e,CA}}{Z_{a,CA}} \quad (\text{Eq. 1, 2 and 3})$$

$$\text{where } Z_{e,AB} = \frac{u_{AB}}{i_{AB}}; \quad Z_{e,BC} = \frac{u_{BC}}{i_{BC}}; \quad Z_{e,CA} = \frac{u_{CA}}{i_{CA}}$$

- $M_{p,A}, M_{p,B}, M_{p,C}$  : Pressure Sensitivities of microphones A, B and C
- $Z_{a,AB}, Z_{a,BC}, Z_{a,CA}$  : Acoustic Transfer Impedances of coupler with microphones AB, BC and CA
- $Z_{e,AB}, Z_{e,BC}, Z_{e,CA}$  : Electrical Transfer Impedances of coupler with microphones AB, BC and CA

The international Pressure Reciprocity Calibration Standard IEC 61094-2 (renamed from IEC 1094-2) gives much more information and details, especially on the determination of the Acoustic Transfer Impedance. In the middle of the frequency range this is essentially determined by the volume of the coupler cavity and of the properties of the enclosed air (gas) but it is also influenced by the acoustic impedance of the microphone diaphragms.

In the lower part of the frequency range the acoustic transfer impedance is in addition also influenced by the heat conduction process which occurs at the coupler surfaces and leads to a decreasing pressure with decreasing frequency. The calibration results have to be corrected for the influence of this effect which today is carefully analyzed and described in the IEC standard.

At higher frequencies, where the wavelengths approach the dimensions of the coupler cavity the acoustic transfer impedance becomes highly influenced by wave motion in the cavity. This complicates an accurate determination of the impedance. In principle there are two ways to overcome this problem. One way is to minimize the wave motion by replacing the air in the coupler by a gas having a high speed of sound, like Helium or Hydrogen. Another possibility is to shape the coupler in such a way that the influence of the wave motion becomes predictable by simple and reliable calculations. As the first method

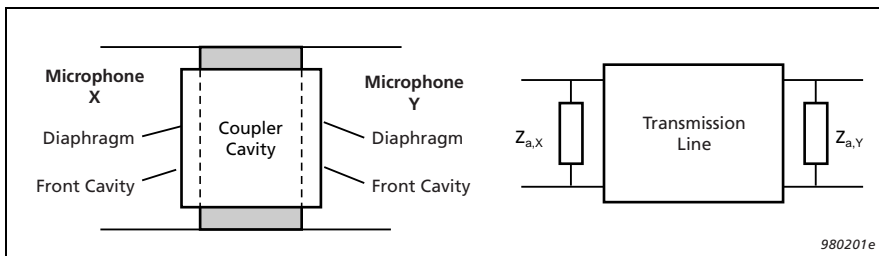

*Fig. 3. Plane Wave Coupler and its model. The model uses a transmission line to represent the coupler cavity. This is terminated by acoustic impedances which represent the microphone diaphragms*



implies several practical problems the second method is today the most commonly used. With this method the coupler cavity is shaped like a cylinder with same diameter as the microphone diaphragms. Wave motion will occur in such couplers but essentially only in the axial direction. Such couplers are called plane wave couplers, see Fig. 3. Their shape and dimensions make it possible to calculate the acoustic transfer impedance by using the theory of transmission lines. The expression below originates from IEC 61094-2 and defines the acoustic transfer impedance.

The transfer impedance  $Z_{a, XY}$  is given by:

$$\frac{1}{Z_{a, XY}} = \frac{1}{Z_{a, 0}} \left[ \left( \frac{Z_{a, 0}}{Z_{a, X}} + \frac{Z_{a, 0}}{Z_{a, Y}} \right) \cosh(\gamma \cdot l_{XY}) + \left( 1 + \frac{Z_{a, 0}}{Z_{a, X}} \cdot \frac{Z_{a, 0}}{Z_{a, Y}} \right) \sinh(\gamma \cdot l_{XY}) \right] \quad (\text{Eq.4})$$

where

- $Z_{a,0}$ : Characteristic impedance of acoustic transmission line with cross section area like the coupler cavity
- $Z_{a,X}, Z_{a,Y}$ : Acoustic diaphragm impedance of the microphones (X and Y)
- $\gamma$ : Complex propagation coefficient
- $l_{XY}$ : Coupler cavity length

To summarize the above description, a reciprocity calibration requires measurement of electrical transfer impedance and determination of acoustic transfer impedance for each pair of microphones followed by a sensitivity calculation involving solution of the above shown equations 1, 2 and 3.

## History of Pressure Reciprocity Calibration Instruments

In the Forties the reciprocity calibration method was invented and initially analysed at the National Bureau of Standards USA by Richard K. Cook. In the Fifties the first standard instrument for reciprocity calibration was developed by Brüel & Kjær. It was basically an instrument with facilities for mounting the microphones and coupler and for measurement of the transmitter microphone current. An external generator and a measurement amplifier which served as a voltmeter were connected to the instrument.



*Fig. 4. Reciprocity Calibration Apparatus Type 4143. Manual instrument for reciprocity calibration of microphones which is widely used today*

In this type of instrument the current of the transmitter microphone was determined by measuring the voltage across a calibrated capacitor which was connected in series with the transmitter. Proper selection of capacitance makes this voltage (which represents the transmitter current) of the same order of magnitude as the receiver output voltage, independent of the frequency. Thus the determination of the electrical transfer impedance becomes a measurement of a voltage ratio which can be carried out easily and accurately. This method is still being used with B&K reciprocity calibration instruments.

The first types of instruments measured the combined sensitivity of the microphone and the applied preamplifier. In some cases this was afterwards corrected for the loading and for the gain of the preamplifier to obtain the open circuit sensitivity. Later preamplifiers with insert voltage facility became available. The insert voltage calibration technique makes it possible to correct for the loading and determine the open circuit sensitivity directly. Today this is the sensitivity which is generally measured and stated by primary calibration laboratories. The open circuit sensitivity is valid for a standardized configuration and dimensions of preamplifier terminals and is not related to any specific preamplifier, see IEC 61094-1.

In the beginning of the Seventies Brüel & Kjær developed a self-contained calibration instrument Reciprocity Calibration Apparatus Type 4143 which only needed an external generator, see Fig. 4. This instrument which is still widely used, represented a great step forward with respect to accurate determination of the electrical transfer impedance.

The instrument which contains a precision voltage comparator and attenuator reduced the uncertainty of the measured electrical transfer impedances by a factor of five to ten and made future improvements of accuracy a question of better determination of the acoustic transfer impedance.

In the past reciprocity calibration systems were manually operated. This made the measurements and succeeding calculations a very time consuming task. Therefore, it was common to limit the number of calibrations as much as

possible by having long time intervals between the periodic calibrations and by measuring at only a few frequencies.

Even though this type of instrument was faster than its predecessors it was still quite slow. This was changed when Brüel & Kjær modified some of them for automatic PC controlled operation. The first modifications were made for use within the company itself in 1991 when Brüel & Kjær was officially nominated as the Danish Primary Laboratory of Acoustics.

The experience with this type of system finally lead to the development and release of a completely new PC controlled calibration system in 1997. The features of this fast and accurate system is described in the following.

## New Pressure Reciprocity Calibration System

The new pressure reciprocity calibration system Type 9699 consists of the following main parts:

- 1) An automated system for measurement of voltage ratio (electrical transfer impedance).
- 2) A pair of plane wave couplers for each microphone dimension (one inch and half inch).
- 3) A sensitivity calculation program developed according to IEC 61094-2 (MP.exe).
- 4) A measurement chamber for noise reduction, static pressure stabilization and pressurization.

### *Automated Voltage Ratio Measurement System*

A block diagram of the measurement system is shown in Fig. 5. The core instrument, the Reciprocity Calibration Apparatus Type 5998 contains two measurement channels with identical signal conditioning amplifiers and selectable high pass filters for low frequency noise reduction. The receiver microphone is mounted on a preamplifier with insert voltage facility which is connected to one of the channels. The transmitter microphone is mounted on a transmitter unit and is connected to the other channel. This unit contains a known series capacitor for measurement of the transmitter microphone current. Both preamplifier and transmitter units have low output impedance which make it possible to place the microphones being calibrated remote from the measurement system itself.

The signal generator supplies the driving signal to the transmitter microphone via an amplifier contained in Type 5998 and via the transmitter unit. The output voltage of the two measurement channels is measured by the dig-

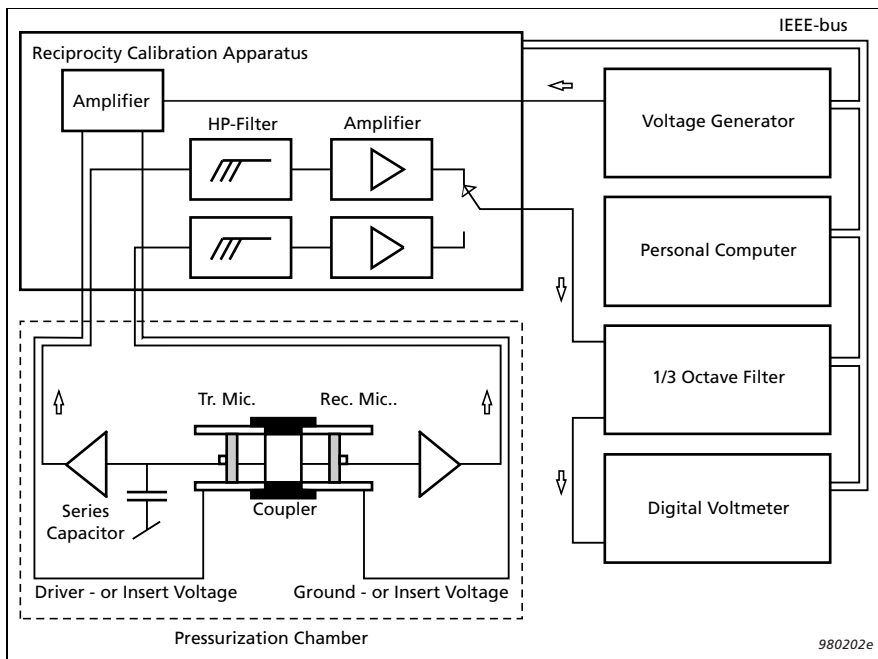

Fig. 5. Reciprocity Calibration System Type 9699. The transmitter and receiver microphones are connected to the Reciprocity Calibration Apparatus Type 5998 with amplifiers having very high input and very low output impedances. The low output impedance makes it possible to mount the microphones and coupler in a separate measurement chamber. As the chamber may be pressurized, sensitivities may be determined at different pressures and pressure coefficients may be calculated

ital voltmeter which is connected via a third octave band-pass filter. All instruments and measurements are controlled by a personal computer and a Windows<sup>®</sup> based measurement program. The program calculates the voltage ratio and stores all data in a measurement file which is later used by the sensitivity calculation program.

With the default settings of the program a voltage ratio is measured in about 35 seconds. This implies that a measurement series from 25 Hz to 25 kHz lasts for about 18 minutes with third octave steps. Consequently a complete calibration of three microphones can be made in about an hour and a half. This includes the three ratio measurements, exchange of microphone

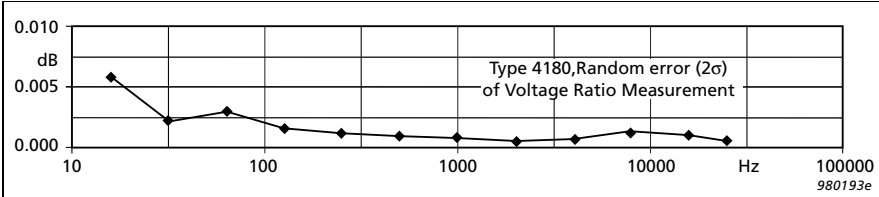

Fig. 6. Random error of Voltage Ratio measurements obtained with Type 9699. The graph shows  $2\sigma$  values (95% confidence level) determined from 10 measurements at each frequency

pairs and time for the succeeding sensitivity calculation. With the previous manual systems such a calibration would have taken several days.

High reproducibility and high absolute accuracy of the voltage ratio measurements have been main design goals for Type 9699. Therefore, special attention has been paid to reduction of environmental and inherent noise and of cross-talk which may disturb the measurements.

The design of the measurement chamber and the low-pass and band-pass filters give a good signal to noise ratio also under laboratory conditions where no specific attention has been paid to background noise. This implies a repeatability of the voltage ratio measurements better than 0.004 dB above 31.6 Hz and better than 0.002 dB above 125 Hz, see Fig. 6. It also means that this random error has only minor influence on the overall calibration uncertainty.

Systematic errors may occur due to gain difference between the receiver and transmitter measurement channels of the Reciprocity Apparatus and due to non-linearity of the voltmeter. Therefore, a high quality voltmeter is chosen and the minor gain difference which may occur is automatically measured by the insert voltage calibration technique and is incorporated in the calculations at each frequency.

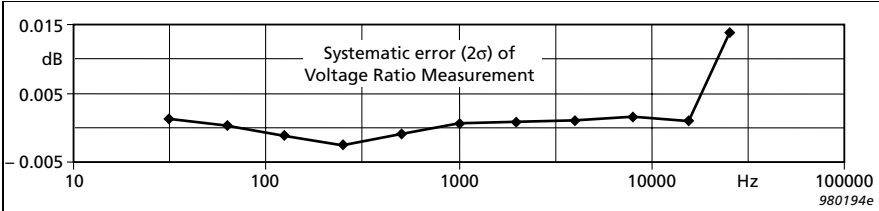

Fig. 7. Systematic error of Voltage Ratio measurement. The error is measured by using an electrical reference standard which is developed by National Physical Laboratory (UK). The result is obtained with a system similar to Type 9699 used by DPLA (explained later)

A few years ago an internal Brüel & Kjær calibration system (which is similar to this new system) was tested by using an electrical reference standard which simulates a coupler with two microphones. This reference which was calibrated by the National Physical Laboratory in London replaced the acoustic parts during the test. The result showed that the systematic error of the measured voltage ratio was very small and also that the principle of the applied system was quite adequate, see Fig. 7.

### *Plane Wave Couplers*

The system uses plane wave couplers, see Fig. 8. For one inch and half inch microphones they may be used up to 12.5 kHz and 25 kHz respectively. The most essential part of the coupler which forms the acoustic coupling cavity is precision machined and made of single crystal sapphire. This ensures good sealing to the microphones and the highest possible long term and temperature stability of the cavity dimensions. For each size (diameter) of microphone there are two couplers with different cavity lengths, see table on next page.

Measurements made with the same microphones in both couplers make it possible to determine the microphone front volumes individually and thus to obtain a lower resulting calibration uncertainty.

As the sapphire ring may be removed from its holder the dimensions may easily and accurately be measured by a mechanical measurement laboratory.

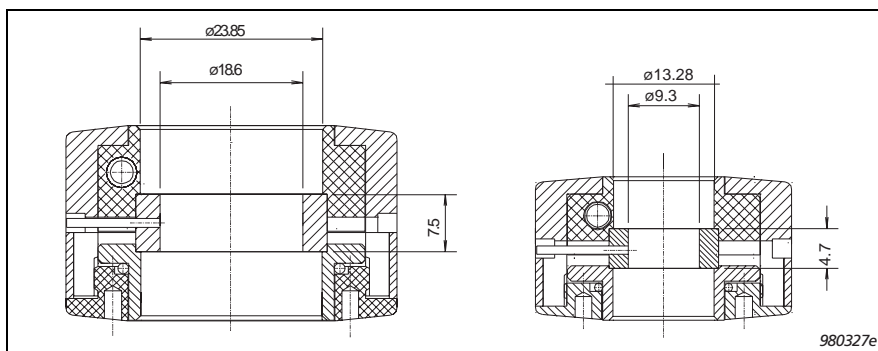

*Fig. 8. Plane-wave couplers for IEC 61094-1 LS1 (1") and LS2 (1/2") microphones. To ensure the highest possible stability the critical part of the couplers are made of single crystal sapphire. Type 9699 contains two couplers for each size of microphone. This makes it possible to estimate microphone volumes*

Coupler Type	Microphone Type	Volume (mm <sup>3</sup> )	Length (mm)	Diameter (mm)	Frequency Range (Hz)
UA 1413 (1")	IEC-LS1p (4160)	4076	15.0	18.6	20–7000
UA 1429 (1")	IEC-LS1p (4160)	2038	7.5	18.6	20–12500
UA 1414 (1/2")	IEC-LS2p (4180)	639	9.4	9.3	20–13000
UA 1430 (1/2")	IEC-LS2p (4180)	319	4.7	9.3	20–25000

### *Measurement Chamber*

Type 5998 includes a measurement chamber which encloses the microphones and the coupler; see Fig. 9. As mentioned above the chamber attenuates the ambient noise around the microphones by about 30 dB and makes valid measurements possible even in quite noisy laboratory environments. The chamber may also be used for stabilization of the static pressure around the coupler and microphones. This means that highly repeatable measurements can be made also on days with non-stable weather. Finally the chamber may be pressurized permitting measurements at different ambient pressures. This facility is especially important for accurate comparison of calibration results between laboratories located at different heights above sea level.



*Fig. 9. The sound isolating measurement chamber of Type 9699. The chamber may be pressurized to any value between that of sea level and Mexico City*

The same facility may also be used for determination of static pressure coefficients of Reference Standard Microphones. The sensitivity coefficients shown in Fig. 10 were thus calculated after reciprocity calibrations at two different static pressures.

Today it is common to accept the performance of calibration at the present ambient static pressure. This measurement chamber makes it possible to calibrate at the reference pressure itself (usually 101.325 kPa).

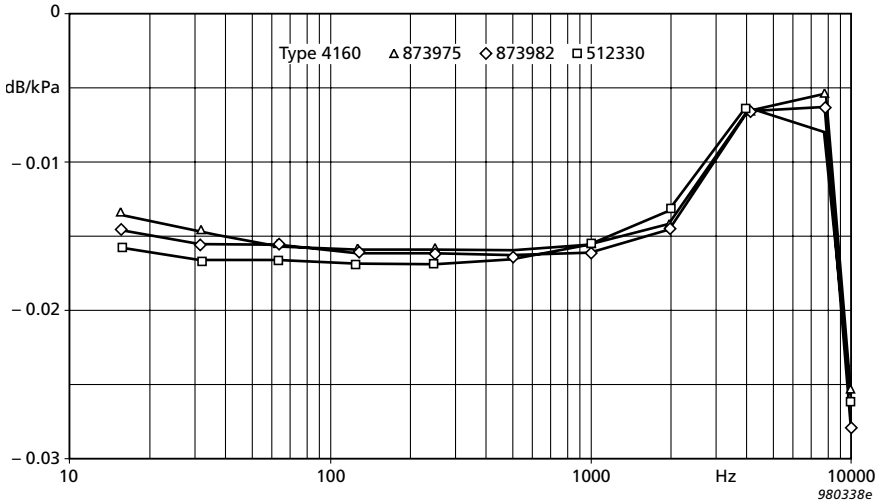

Fig. 10. Individual Static Pressure Coefficients of Laboratory Standard Microphones Type 4160. The Coefficients are determined from reciprocity calibrations made at two different ambient pressures by using the measurement chamber

### Sensitivity Calculation Program

The system includes a program for calculation of the microphone sensitivities (MP.exe). This program is developed by the Department of Acoustic Technology of the Danish Technical University, Lyngby in accordance with the standard for pressure reciprocity calibration (IEC 61094-2). The standard and the program contain the necessary detailed information about the determination of the acoustic transfer impedance (see Eq. 1, 2 and 3) of the couplers. The program gets its input data from the measurement file and from files which store the coupler dimensions and acoustic impedance of the microphones.

The program calculates the sensitivities of the three microphones at the measurement conditions. The sensitivity at the commonly applied reference ambient conditions (101.325 kPa, 23°C and 50% RH) is also calculated. This additional calculation is based on average values of measured temperature and pressure sensitivity coefficients of several Brüel & Kjær Laboratory Standard Microphones. A description of the program is given in a separate article.

The automated measurements and PC calculations have simplified the calibration process and made it applicable also for less specialized acoustic calibration laboratories. The calibration uncertainty which can be expected for the Type 9699 system is described below.



## History of Primary Calibration at Brüel & Kjær

As the leading manufacturer of instruments for acoustic calibrations Brüel & Kjær has delivered reciprocity calibration systems to National Calibration Laboratories all over the world, and the company has also for many years used the instruments itself. Members of the Brüel & Kjær microphone development team have calibrated reference microphones for Brüel & Kjær's world-wide calibration service system and for the company's production departments. Several microphones have thus been systematically reciprocity calibrated since 1967. From 1967 to 1995 two of them were used as transfer standard microphones to ensure traceability for B&K customers to the National Institute of Standards and Technology\* (NIST) in Washington. Their calibration history (250 Hz) is shown in Fig. 11. The graph shows two curves for each microphone. They represent the B&K and the NIST results respectively. Every year one of these two microphones were calibrated by NIST. Notice the high resolution on the graph and the good agreement between the two calibration laboratories, especially for No. 439495. Since 1983 the overall

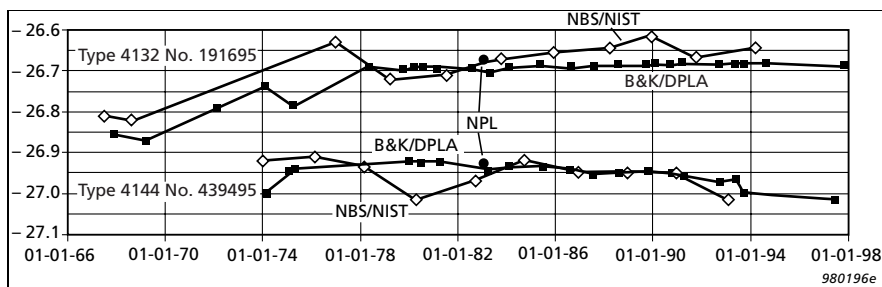

Fig. 11. Calibration results (250 Hz) obtained by NIST and by B&K. During the time of Type 4143 and its successor (since 1977) the spread of the B&K results has been small. During the same time the overall average of the deviations between the two laboratories has been very good. Between 1967 and 1977 the Type 4132 microphone has seemingly changed sensitivity

mean of the deviations between NIST and B&K has been less than 0.02 dB at 250 Hz which is the commonly applied reference frequency.

\* The former National Bureau of Standards (NBS)

During the years comparisons have been made with several other calibration laboratories. After the international round robin calibration which was completed in 1983 a comparison was made with National Physical Laboratory (NPL) in London. This result is also shown in Fig. 11.

For microphone No. 191695 the graph shows a change in the sensitivity results between 1969 and 1978. This change of nearly 0.2 dB was detected by both laboratories. Therefore, the change is most probably due to a mechanical change in the microphone and not due to uncertainty of the calibrations. Such mechanical changes may occur but they rarely cause sensitivity changes as large as this. When such changes are seen with laboratory standard microphones they are typically of the order of 0.01 dB to 0.02 dB. Even if most reference microphones stay stable it is thus recommended to use a set of at least three microphones for all important standards like National Reference Standards.

Since 1967 B&K has used three different reciprocity calibration systems and instruments. Type 4142 was used until 1975-76. At that time it was replaced by Type 4143 which can measure voltage ratios much more accurately by using a precision attenuator and an accurate meter. This improvement is clearly reflected in the much better reproducibility of the results from 1976 to 1990, see Fig. 11.

In 1991 the Danish Government nominated Brüel & Kjær as the Danish Primary Laboratory of Acoustics (DPLA). The nomination was based on the company's know-how and experience with microphone and accelerometer calibration. Due to the nomination and the generally increasing need for calibration, B&K made an automated calibration system for DPLA (an independent department of B&K). The operation principle of this Type 4143 based system is similar to that of the newly released Type 9699 system. This system has been used during the Nineties. As can be seen the automated calibrations made since 1990 are in good agreement with the previous results, see Fig. 11.

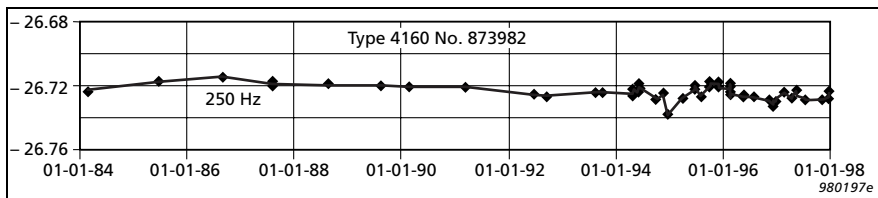

Fig. 12. Reciprocity calibration results (250 Hz) obtained with a one inch microphone Type 4160. The deviation from a linear regression line is  $<0.01$  dB ( $2\sigma$ ) over a period of 14 years

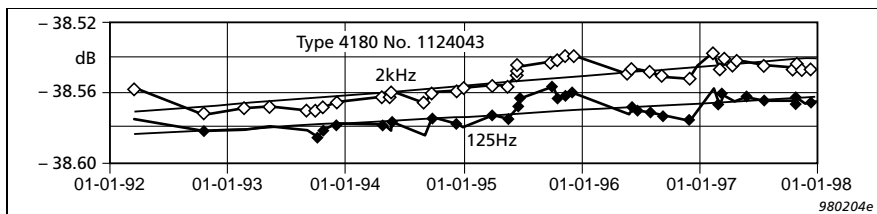

Fig. 13. Reciprocity calibration results (125 Hz and 2 kHz) obtained with a half inch microphone Type 4180. The deviations ( $2\sigma$ ) from the linear regression lines are  $< 0.012$  dB over a period of 6 years

Today, the above-mentioned microphone types (Type 4132 and Type 4144) are not used as NIST transfer standards. For this and most other reference applications these types have been replaced by Type 4160. This type is produced within more narrow tolerances, is better documented and has a fixed cavity in front of the diaphragm which is formed by a non-removeable ring. Type 4160 is, therefore, better suited for accurate and repeatable calibrations than the previous types. See 250 Hz results from 1984 to 1998 in Fig. 12. Today, Type 4160 is routinely calibrated from 31.5 Hz to 10 kHz.

Half inch laboratory standard microphones are also used as references. Today, this is becoming more and more common. The B&K microphone Type 4180 has thus been systematically calibrated by DPLA and Brüel & Kjær for several years. This type is calibrated up to 25 kHz with a very good accuracy; see the results given in Fig. 13.

The long time spread of the DPLA reciprocity calibrations (like those shown in Figs. 12 and 13) was calculated as a function of frequency. The spread valid for Types 4160 and 4180 (over 14 and 6 years respectively) was worked out relative to a linear regression line in order to separate any long term drift of the microphone sensitivity from the DPLA systems calibration ability. The long

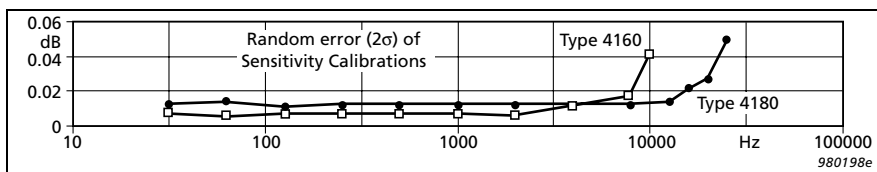

Fig. 14. Random calibration errors ( $2\sigma$  deviations from linear regression lines) as a function of frequency. The errors are calculated for the above-mentioned one inch and half inch microphones

term spread ( $2\sigma$ ) which contains random errors of both the acoustical and the electrical transfer impedances and of the ambient microphone corrections was found to be close to 0.01 dB for both types. It was slightly lower for Type 4160 than for Type 4180 and increased for both types above 4 kHz, see Fig. 14.

## Calibration Results Obtained with Type 9699

The calibration system Type 9699 is new. Therefore, no historical sensitivity results have been produced to create confidence in the system. To overcome this problem a series of measurements were made to compare the results of the new system with those of the old DPLA system which has produced highly reproducible and reliable results over the last 6 years.

Series of measurements were made with both half inch and one inch microphones and with both short and long plane-wave couplers. All measurements which were made with a certain set of microphone and a specific coupler were performed on the same day with both calibration systems. No differences between the results could be traced back to the two systems. An example of a result valid for a half inch microphone is shown in Fig. 15. This shows comparison of microphone sensitivity as measured with the two systems with a long coupler (31.6 Hz to 2 kHz) and with a short coupler (31.6 kHz to 25 kHz). All results are displayed relative to their average value.

The series of measurements made to test the new system showed that this produces reproducible and reliable results which are comparable with those of the well-documented and established DPLA system.

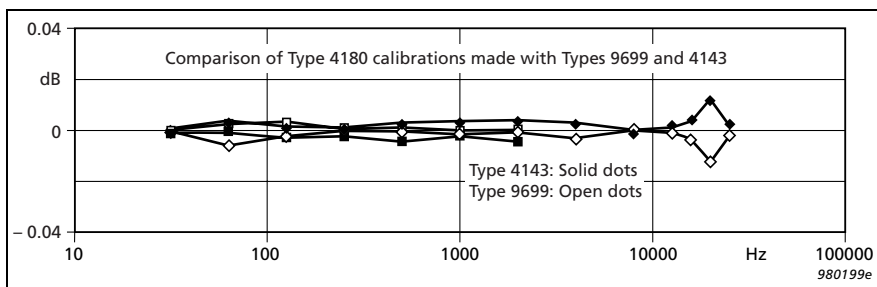

Fig. 15. Calibration result (example) obtained for microphone Type 4180 No. 1124043 with a Type 9699 system (new) and with the well-documented Type 4143 system. A series of measurements have shown that no difference can be traced back to system differences

## Uncertainty of DPLA's Primary Pressure Calibrations

In connection with the formation of DPLA the Danish government required that DPLA should achieve an accreditation from the Danish Accreditation Body DANAK. Therefore, the uncertainty of the primary microphone reciprocity calibration had to be further analysed and evaluated. The required analysis which was made in 1991 did not lead to any significant changes, neither of the measurement nor of the calculation procedures. No step change can, therefore, be seen on the long term sensitivity graphs; see example in Fig. 12. The uncertainty of DPLA calibrations is claimed to be  $\pm 0.03$  dB ( $2\sigma$ ) for one inch microphones in the best frequency range (125 Hz to 4 kHz) while it is  $\pm 0.04$  dB for half inch microphones. NIST stated  $\pm 0.08$  dB for their calibrations. The uncertainty calculations are discussed below.

This section deals with calculation of DPLA's calibration uncertainty. It briefly describes the applied calculation method and shows the results obtained for the Types 4160 and 4180. The sensitivity of a microphone (A) is determined from acoustical and electrical transfer impedances ( $Z_a$  and  $Z_e$ ) which are valid for the three pairs of microphones (AB, BC, CA). It is defined by the equation below which is derived from Equations 1, 2 and 3.

$$M_{p,A} = \sqrt{\frac{Z_{a,BC}}{Z_{a,AB} \times Z_{a,CA}}} \times \sqrt{\frac{Z_{e,AB} \times Z_{e,CA}}{Z_{e,BC}}} \quad (\text{Eq. 5})$$

According to general uncertainty calculation principles and to the *Guide to the Expression of Uncertainty in Measurement* which is issued by BIPM, ISO, IEC and other organizations the overall uncertainty of the sensitivity determination is given by the square-root of the sum of variances valid for the acoustical and electrical impedances. Each of them are influenced by the uncertainty of several input quantities.

It should be noted that a systematic error of a specific quantity influences all electrical or all acoustical impedances equally (see Eq.5) while a random error influences them differently. A systematic error is thus partly equalized due to its correlated influence on the numerator and the denominator. The effect of a systematic error corresponds to influencing one parameter only while all three are influenced by a random error. The ratio between influences of equally large systematic and random errors is thus  $1:\sqrt{3}$ . After determination of the system-

atic and the random error of each specific input parameter they are combined by using the above weighting factors, see Eq.6.

$$\Delta Q_i = \left( \Delta Q_{i,sys}^2 + (\sqrt{3} \times \Delta Q_{i,ran})^2 \right)^{0,5} \quad (\text{Eq.6})$$

$$\Delta M_p(f)[dB] \equiv \sqrt{\sum_{i=1}^N \left( \Delta Q_i \times \frac{dM_p(f)}{dQ_i} [dB] \right)^2} \quad (\text{Eq.7})$$

- $\Delta M_p(f)$  : Calculated uncertainty (dB) of microphone pressure sensitivity
- $\Delta Q_{i,sys}$  : Systematic uncertainty of input quantity (i) influencing the pressure sensitivity
- $\Delta Q_{i,ran}$  : Random uncertainty of input quantity (i) influencing the pressure sensitivity
- 1.. .N : Identification numbers of input quantities
- $\frac{dM_p(f)}{dQ_i}$  : Change of sensitivity for change of input quantity (i)

The influence of an input parameter error depends on the parameter itself and on the frequency. Its contribution to the uncertainty of the calculated sensitivity was found by multiplying the error by a coefficient which represents the frequency dependent sensitivity to a change in the specific parameter.

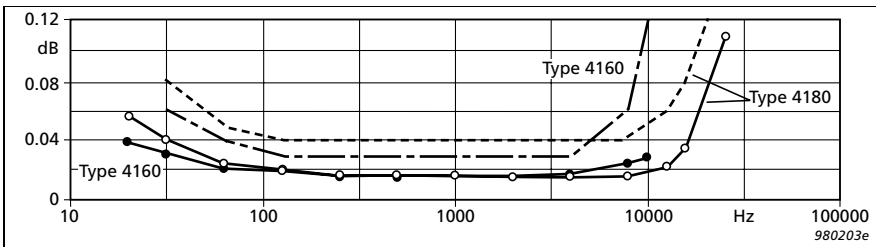

Fig. 16. Calculated and specified uncertainty for customer calibrations performed by DPLA. It was considered that the values and equations stated in IEC 61094-2 are correct. The uncertainty belongs to the best in the world of National Laboratories

The coefficients were determined by using the reciprocity sensitivity calculation program. Variations in calculated sensitivity were related to variations in input parameters.

The uncertainty of the microphone sensitivity which is valid at measurement conditions were found in accordance with Equation 7. The sensitivity at ambient reference conditions is found by correcting that valid for measurement conditions. The uncertainty of the corrections were calculated and included in the overall uncertainty of the sensitivity shown in Fig. 16.

For this calculation it was considered that the contents of the International Standard IEC 61094-2 is correct. The calculation therefore does not take possible errors in the standard and its principles into account.

The uncertainty of DPLA is low and among the very best in the world. This is partly due to the experience and routine gained with the high calibration activity of the laboratory and partly due to the modern calibration system which works with a high reproducibility and small systematic errors.

However, there is always a risk of human errors. To keep this risk low DPLA always includes at least one own reference microphone with a long term calibration history when reciprocity calibrations are made for customers. If a calibration error should occur the calibration result of this microphone will most probably differ from those of the history and indicate that something is wrong.

Possible future efforts to improve the calibration uncertainty should be concentrated on parameters which influence the acoustic transfer impedance. The pressure and temperature of the coupler gas would be important together with the impedance of the microphone diaphragms and front cavities. Also microphone coefficients for static pressure and temperature should be further analyzed. The measurement chamber of Type 9699 which may be pressurized can be used for that.

## Conclusion

Intensive research, new international standards and new improved instruments for pressure reciprocity calibration have lead to microphone sensitivity results which today are 5 to 10 times better than they were 30 years ago. The results of today are better with respect to reproducibility and to overall uncertainty.

Furthermore, the new calibration systems which are automated have improved the productivity of reciprocity systems by at least 10 times and thus made calibrations over wide frequency ranges possible in practice. The risk of

operator errors is also reduced with the new system as both measurements and calculations are controlled by PC software.

The measurement chamber which is a part of the Calibration System Type 9699 eases inter-laboratory comparison calibrations and measurement of microphone pressure coefficients as it may be pressurized to any pressure between that at sea level and that at a high altitude city such as Mexico City.

Today, half inch microphones are increasingly used as Reference Standard Microphones but long series of calibration results have shown that the repeatability obtainable with one inch microphones is slightly better. Therefore, one inch microphones will probably also be used in the future, especially for the most accurate calibrations below 4 to 8 kHz while half inch microphones will cover the full range up to 25 kHz.

Uncertainty calculations are made for one and half inch microphone calibrations. Below 10 kHz the results are practically equal for the two sizes and they are close to 0.02 dB ( $2\sigma$ ). For these uncertainty calculations the considerations of the international standard IEC 61094-2 were assumed to be correct. The Danish Primary Laboratory of Acoustics specifies tolerances for customer calibrations which are approximately twice as large.

## References

- [1] "*Measurement microphones*", International Standard, IEC 61094-1, 1992-05
- [2] "*Primary method for pressure calibration of laboratory standard microphones by the reciprocity technique*", International Standard, IEC 61094-2, 1992-03
- [3] "*Primary method for free-field calibration of laboratory standard microphones by the reciprocity technique*", International Standard, IEC 61094-3, 1995-11



# MP.EXE, a Calculation Program for Pressure Reciprocity Calibration of Microphones

*Knud Rasmussen*\*

A computer program is described which calculates the pressure sensitivity of microphones based on measurements of the electrical transfer impedance in a reciprocity calibration set-up. The calculations are performed according to the International Standard IEC 61094-2. In addition a number of options allows the user to improve his calculations by introducing corrections not yet implemented in IEC 61094-2 such as corrections for the influence of radial wave-motion in the couplers. A special feature, the ability to refer the calculated sensitivities to reference environmental conditions by means of the complex static pressure- and temperature coefficients for B&K Types 4160 and 4180 microphones, is included in the program.

## Résumé

Le logiciel pour PC décrit ici calcule la sensibilité en pression des microphones sur la base de l'impédance électrique de transfert entre deux microphones placés dans un montage de mesure d'étalonnage par réciprocité. Les calculs sont effectués selon la Norme internationale CEI 61094-2. Un certain nombre de fonctions permet d'améliorer les calculs par l'introduction de corrections non encore mises en œuvre par cette Norme, telles que la correction de l'influence du déplacement des ondes radiales dans les coupleurs. Une caractéristique spéciale a été incluse au logiciel : la possibilité de lier les sensibilités calculées aux conditions environnementales de référence par le biais des coefficients de température et de pression statique pour les Microphones B&K Type 4160 et 4180.

---

\* Danish Primary Laboratory of Acoustics, DTU Branch,  
Department of Acoustic Technology, Danish Technical University

# Zusammenfassung

Es wird ein Computerprogramm beschrieben, das den Druck-Übertragungsfaktor von Mikrofonen auf der Basis von Messungen der elektrischen Übertragungsimpedanz in einer Einrichtung zur Reziprozitätskalibrierung berechnet. Die Berechnungen werden nach der internationalen Norm IEC 61094-2 ausgeführt. Darüber hinaus erlauben mehrere Optionen dem Benutzer, seine Berechnungen durch Korrekturen zu verbessern, die noch nicht in IEC 61094-2 implementiert sind, z.B. für den Einfluß radialer Wellenbewegung in den Kupplern. Eine Besonderheit des Programms ist die Möglichkeit, die berechneten Übertragungsfaktoren auf Bezugs-Umgebungsbedingungen zu beziehen. Dies erfolgt mit Hilfe der komplexen statischen Druck- und Temperaturkoeffizienten für die Brüel & Kjær-Mikrofone 4160 und 4180.

## Introduction

MP.EXE is a computer program which calculates the pressure sensitivity of laboratory standard microphones as defined in IEC Publication 61094-1, 1992, ref.[1], based on measurement results obtained by a reciprocity calibration in a closed coupler, performed as laid down in IEC Publication 61094-2, 1992, ref.[2].

The program is originally developed at the Department of Acoustic Technology, Technical University of Denmark for research purposes and later developed into a more universal program covering virtually all possible aspects for performing a reciprocity pressure calibration using three microphones, mutually coupled by a passive cylindrical coupler as described in ref.[2].

The program is written so that it can be executed without user communication if the measurement data filename is given as a parameter when calling the program and provided that the necessary microphone and coupler data files are available. This means that the program can be called from other programs, like a database or spreadsheet and hence be integrated in a complete measurement system such as B&K Reciprocity Calibration System Type 9699.

The present version is particularly useful for Calibration Laboratories holding an accreditation on pressure reciprocity calibration of microphones. For this reason the default mode of the program follows the procedure prescribed in IEC 61094-2, ref.[2] very closely. Other options allows the user to benefit from various improvements not yet implemented in IEC 61094-2.

The program is designed to work on all IBM<sup>®</sup> PC compatible computers with MS/PC DOS version 3.00 or later.

## Principles of Reciprocity Calibration Technique

The basic principles of performing a pressure reciprocity calibration are described in IEC 61094-2, ref.[2]. Two microphones (1) and (2) are coupled by a closed cavity using one as a sound source and the other as a sound receiver. The electrical transfer impedance of the coupled microphones  $Z_{e,12}$ , i.e. the ratio of the open-circuit voltage of the receiver microphone to the driving current through the transmitter microphone is then measured as function of frequency. Next the acoustical transfer impedance  $Z_{a,12}$ , i.e. the ratio of the sound pressure over the diaphragm of the receiver microphone to the volume velocity of the transmitter microphone is calculated from the dimensions of the coupler and the acoustical impedance of the microphones as described in IEC 61094-2, clause 5. According to the reciprocity theorem the product of the pressure sensitivities of the two microphones is then determined by the ratio of the said two transfer impedances:

$$M_{p,1} \times M_{p,2} = Z_{e,12} / Z_{a,12}$$

When three microphones are coupled successively, three such products can be determined from which the pressure sensitivity of each microphone can be derived.

To measure the electrical transfer impedance the open-circuit voltage of the receiver microphone is determined by the insert-voltage technique, while the current through the transmitter microphone generally is measured by the voltage across a known impedance connected in series with the transmitter microphone. Thus the electrical transfer impedance is generally expressed by a voltage ratio and a measurement impedance. The measurement impedance can be a fixed capacitor in parallel with a large resistance (losses) as is used in B&K Type 5998 Reciprocity Calibration Apparatus. A decade resistance in parallel with a small capacitance (cable- and stray capacitances) is often used in non-commercial equipment. The program accepts both types of measuring impedance.

## Description of the Program

In order for the program to calculate the sensitivities resulting from a calibration three types of datafiles are necessary:

- 1) A file for each microphone specifying the individual parameters for that microphone, such as front volume, front cavity depth, equivalent vol-

ume, resonance frequency, loss factor etc. If the individual data for a given microphone is unknown, typical data for B&K Types 4160 or 4180 may be used. Also information of the complex static pressure-, temperature- and humidity coefficients can be given.

- 2) A file for each coupler specifying the coupler dimensions, volume, surface area, number and dimension of capillary tubes etc. Also information on a particular correction for wave-motion effects can be given. Only two kinds of couplers, viz. Plane-wave couplers and Large volume couplers as defined in IEC 61094-2, Annex C are handled by the program.
- 3) A measurement datafile containing all necessary information on the measurements, i.e. identification of microphones, couplers, environmental conditions and the measured electrical transfer impedance in terms of the complex voltage ratio and measuring impedance for each measurement frequency etc.

These files are all ASCII-files in order to make them easily readable and accessible for editing by any ordinary editor. When executing the program the content of the individual coupler and microphone data files are shown and the data can be modified thereby allowing the user to study the influence of the various parameters on the calculated pressure sensitivity of the microphones.

When the calculations have finished, the results can be viewed on the screen before being printed or saved in a file. The present version of MP.EXE has four different output formats ranging from a comprehensive file for each measurement containing the results and all information given in the data files used, to a small "spreadsheet friendly" result file in a fixed format for each microphone and with a short information of the measurement and calculation conditions.

The results of the calculations are given as the complex pressure sensitivity, in terms of modulus (in dB re 1V/Pa) and phase (degrees) under the actual environmental conditions during the measurements and at reference environmental conditions (23 °C, 101.325 kPa, 50 %RH).

In order to obtain the sensitivities at reference environmental conditions the corresponding static pressure- and temperature coefficients for each microphone must be available as function of frequency. If data for the individual microphone is not available the program contains typical data for B&K Types 4134/4144/4160/4180 microphones.

## Calculation of the Acoustic Transfer Impedance

The methods for calculating the acoustic transfer impedance for Plane-wave and Large volume couplers are given in IEC 61094-2, ref.[2]. In the default mode the program performs the calculation according to this standard, i.e. heat conduction and capillary tube corrections are applied in accordance with Annex A and B in the standard and the acoustic properties of the air in the coupler are calculated in accordance with Annex F.

In addition it is possible to apply a correction for radial wave-motion for plane-wave couplers. The effects of radial wave-motion is described in ref.[2], clause 6.4 but no corrections or method for deriving a correction is given. However, a theory for this correction is described by Rasmussen, 1993 ref.[3] and implemented in the program.

In the optional mode of the program the acoustic properties of the air in the coupler are calculated using the latest available equations for calculating the speed of sound, density, ratio of specific heats etc. for humid air, see Rasmussen 1997, ref.[4]. In this calculation mode a further improvement is introduced by applying the theories described by Ballagh and Jarvis, 1987 ref. [5,6] for the heat conduction and viscosity losses at the cylindrical surface of plane-wave couplers. The option for applying radial wave-motion corrections is also present in this mode.

In both modes of the program it is further possible to disable capillary tube and heat conduction corrections which gives the user an opportunity to study the magnitude of these corrections.

## Static Pressure- and Temperature Coefficients of Microphones

It is often impractical or not possible to perform a reciprocity calibration under or very close to the reference environmental conditions. In order to compare results obtained over longer periods or between laboratories it is necessary to refer the calibration results to the same environmental conditions, viz. the reference conditions. To accomplish this, the normalized complex static pressure- and temperature coefficients, as described in IEC 61094-2, 1992 Annex D, have been experimentally determined for B&K Types 4160 and 4180 microphones and included as default values in the program. The coefficients are based on measurements on about 30 different microphones of each type manufactured over a period of more than 10 years. Figs. 1 and 2 show the normalized complex coefficients for B&K Types 4160 and 4180 microphones.

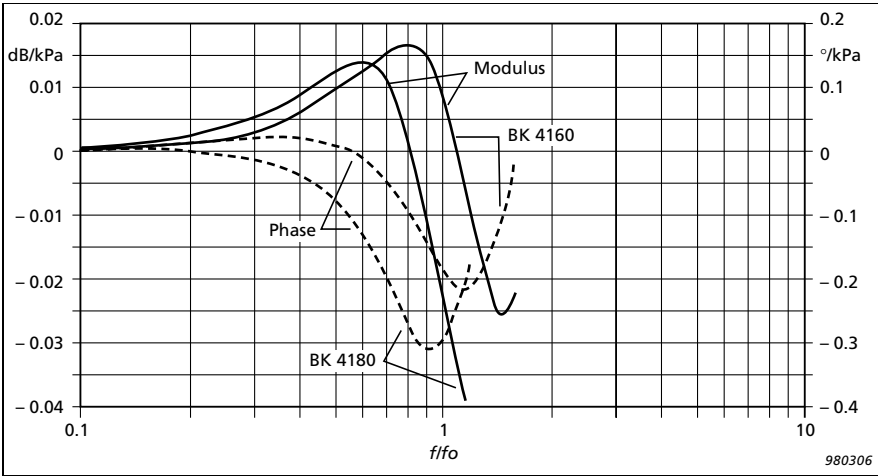

Fig. 1. Complex static pressure coefficients for B & K Types 4160 and 4180 microphones, normalized by the low frequency values and as function of frequency normalized by the resonance frequency of the microphone (—— modulus, - - - - phase)

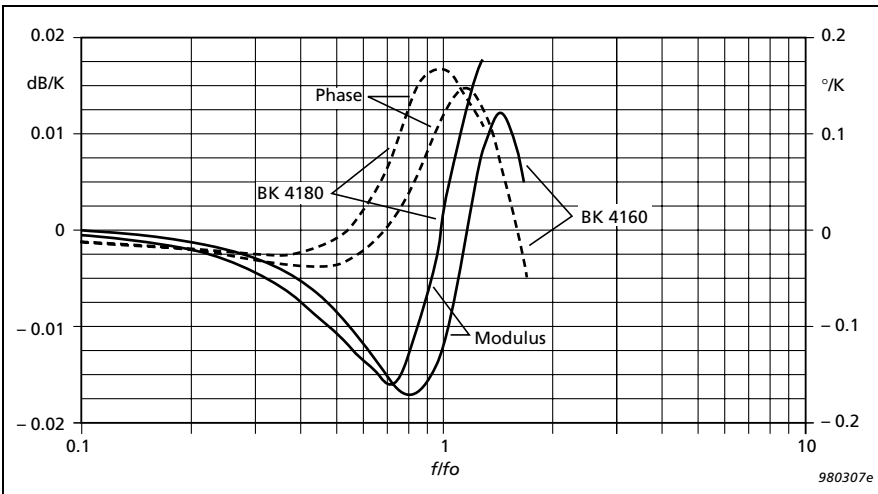

Fig. 2. Complex temperature coefficients for B & K Types 4160 and 4180 microphones, normalized by the low frequency values and as function of frequency normalized by the resonance frequency of the microphone (—— modulus, - - - - phase)

At present reliable data for these coefficients are only available for B&K Types 4160 and 4180. For constructional reasons the same coefficients also apply for Types 4144 and 4134 respectively. However, the frequency dependency is quite different for other types of microphones and thus these coefficients should not be used. It is the intention to include data for other type of microphones as well in the program as soon as reliable data is available.

## Final Remarks

The program is developed at the Department of Acoustic Technology, DTU and is based on the experience gained over several years. A very early program was developed and written by the author of this article, while the code of the present, heavily extended version is written by Erling Sandermann Olsen.

The program can be purchased through DPLA (Danish Primary Laboratory of Acoustics) or through Brüel & Kjær.

## References

- [1] IEC Publication 61094-1, 1992: “*Measurement microphones – Part 1 – Specifications for laboratory standard microphones*”
- [2] IEC Publication 61094-2, 1992: “*Measurement microphones – Part 2 – Primary method for pressure calibration of laboratory standard microphones by the reciprocity technique*”
- [3] Rasmussen, K., “*Radial wave-motion in cylindrical cavities*”, Acta Acustica, 1, pp. 145-151, 1993.
- [4] Rasmussen, K., “*Calculation methods for the physical properties of air used in the calibration of microphones*”, Report PL-11b, 1997. Department of Acoustic Technology, Technical University of Denmark.
- [5] Ballagh, K.O., “*Acoustical admittance of cylindrical cavities*”, Journal of Sound and Vibration 112, pp. 567 -569, 1987
- [6] Jarvis, D.R., “*Acoustical admittance of cylindrical cavities*”, Journal of Sound and Vibration 117, pp. 390 -392, 1993

